

Compatible with the game:

ARNAK UV PRINT

Assemble based on base element letter then according to numbers from first to last.

Please remove elements out of frame carefully.

Example: while assembling **A** start by inserting all elements **a1** into base element **A**, then all elements **a2** and so on.

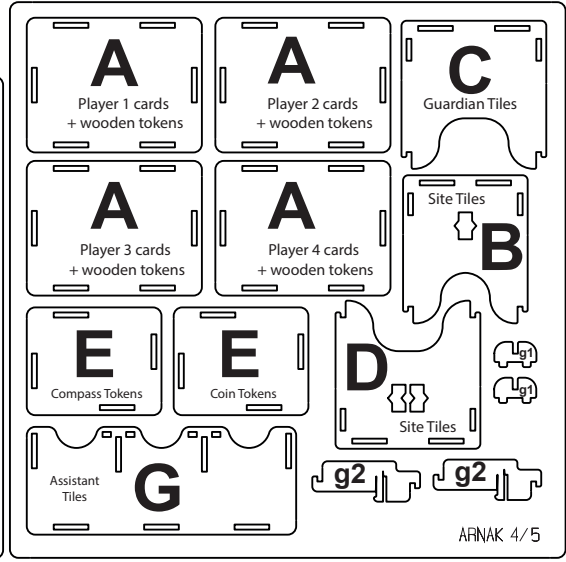
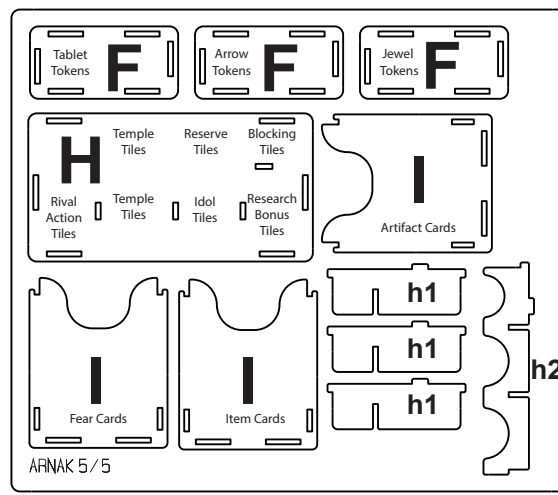
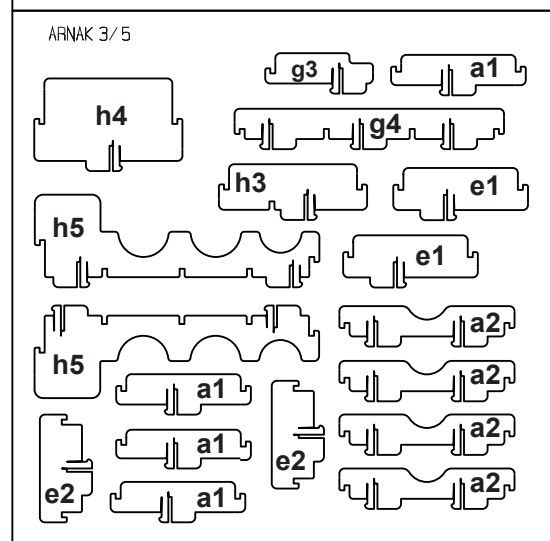
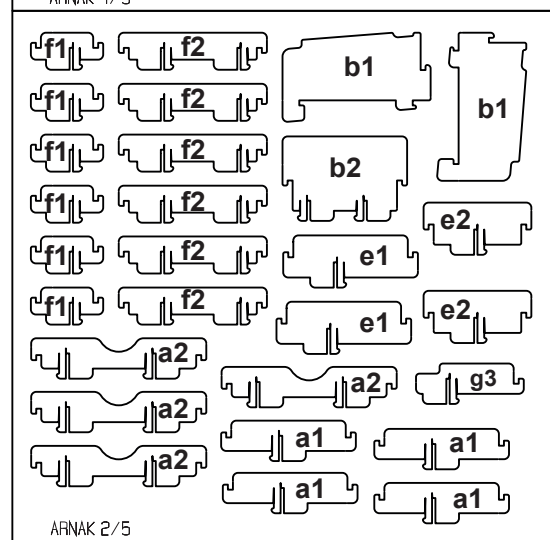
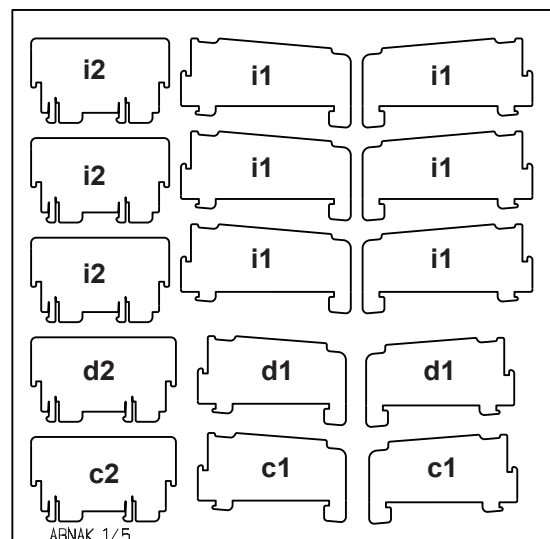
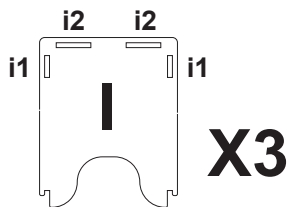
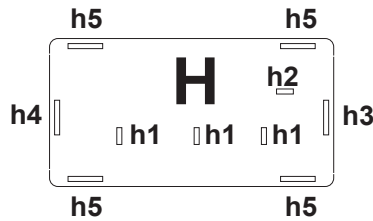
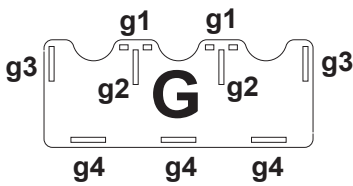
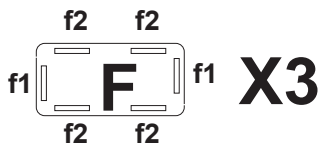
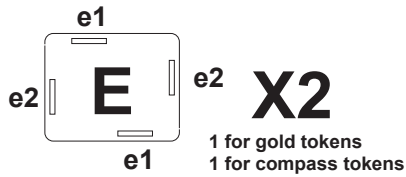
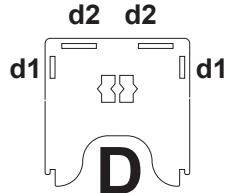
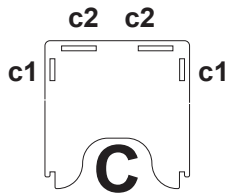
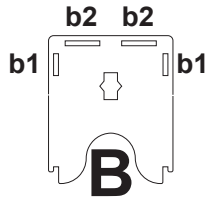
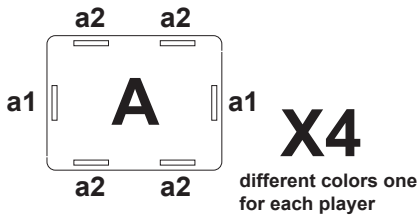

You can check the box arrangement photo samples on our website www.e-raptor.pl